

# ISTRUZIONI DI MONTAGGIO

*assembly instructions*

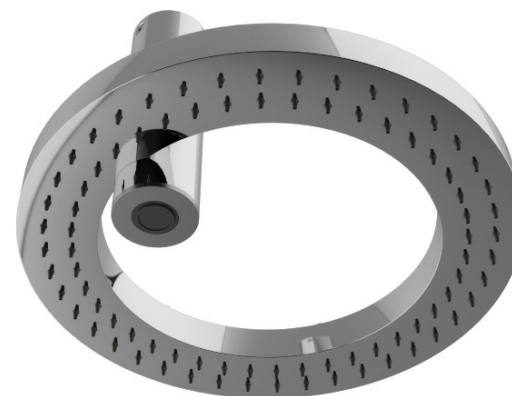

**cod. IT 9B91 CC ZZ LD**



**cod. IT 9B91 CC ZZ ZZ**

# OPZIONI DI MONTAGGIO

mounting options

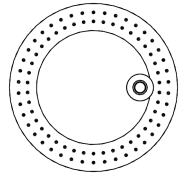

**Versione 1**  
version

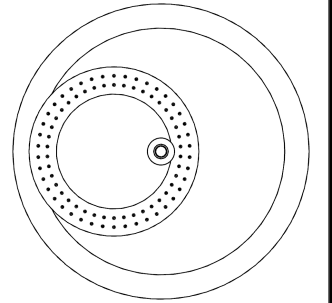

**Versione 2**  
version

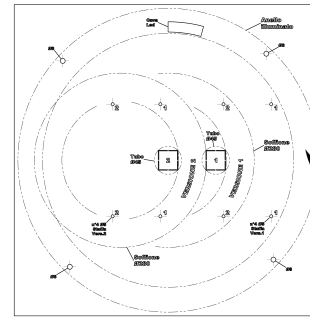

Dima d'installazione  
(install template)

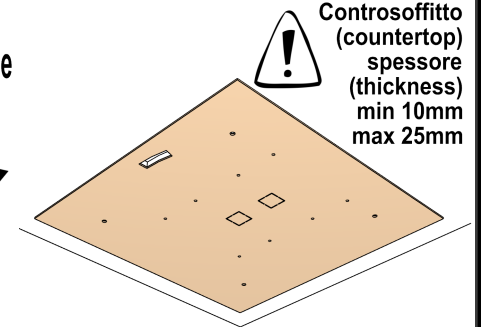

Controsoffitto  
(countertop)  
spessore  
(thickness)  
min 10mm  
max 25mm

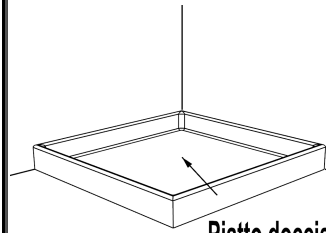

Piatto doccia  
(shower plate)

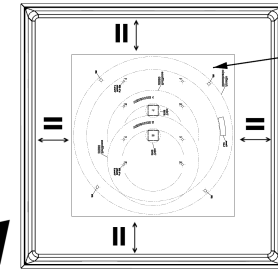

A piacere  
(to like)

Ingresso box doccia  
(shower cabin entrance)

1

Alla prima installazione  
(on first installation)  
Prima di completare  
controsoffitto  
(before completing  
countertop)



Controsoffitto  
(countertop)

Accesso laterale  
(side acces)

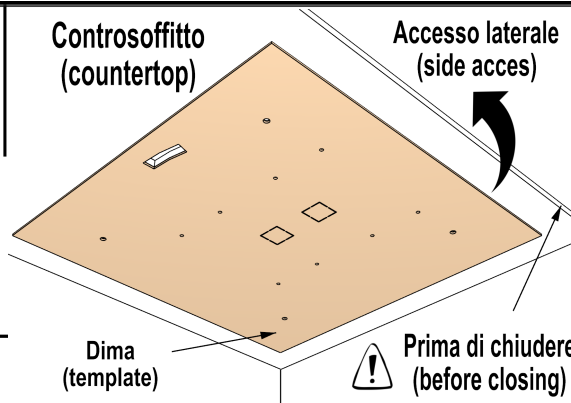

Dima  
(template)

Prima di chiudere  
(before closing)

In alternativa  
(alternatively)

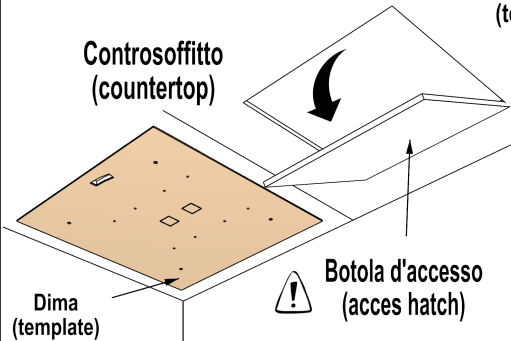

Controsoffitto  
(countertop)

Dima  
(template)

Botola d'accesso  
(acces hatch)

2

Scegliere opzione  
(choose option)

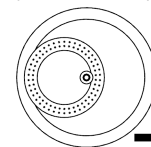

Esempio Versione 2  
(example version 2)

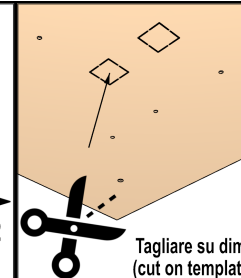

Tagliare su dima  
(cut on template)

Controsoffitto  
(countertop)

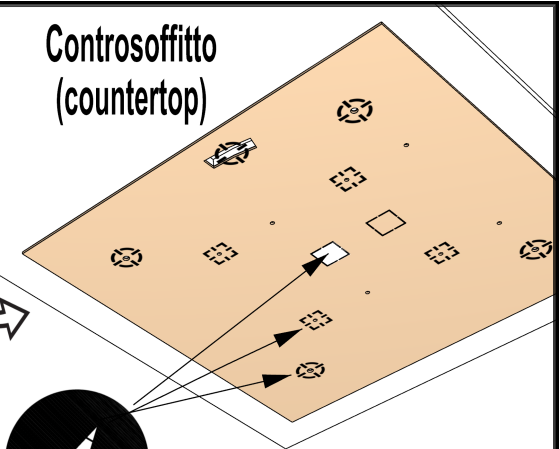

Tracciare quadrato versione scelta  
(draw square of the chosen version)

Per staffa supporto soffione  
(for shower head support bracket)

Per anello LED  
(for LED ring)

3

